



MODULAR FURNITURE

The Ullrich Modular Furniture system employs an adaptable tube-and-jointer modular construction DIY concept for custom designed furniture, shelving, storage and display units.

DESCRIPTION

This aluminium square-tube system assembles in minutes using only a plastic mallet, ready to accept horizontal and vertical panels of your choice. The sturdy, lightweight construction disassembles for transit or storage and rearranged or extended for changing circumstances.

Introduction

Carefully plan your assembly before you purchase your components. The system is available in two profile sizes - select from 25mm or 20mm to suit the purpose of the unit you are planning. To ensure sturdy construction spans between joints should not exceed 960mm.

The system features a flanged tube specially designed to fit your choice of panelling in two thicknesses, flush with the frame, simply by turning the profile 180°, e.g.:

25mm flanged tube carries 18mm timber frame or 6mm glass.

20mm flanged tube carries 12mm timber frame or 5mm glass.

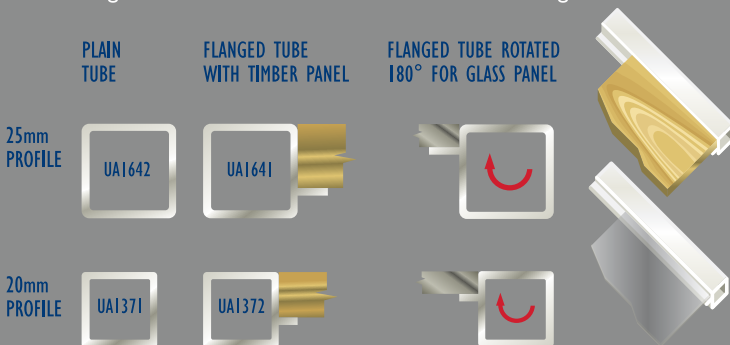

Using modular tube for simplicity and flexibility

Note how jointed selections of shorter modules combine in various ways to equal the lengths of jointed longer tube modules. This offers multi-strata design flexibility, vertically and laterally, to customise storage or workspace with maximum efficiency and economy.

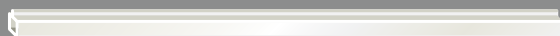

One 875mm module (with any two jointers) is equal to:

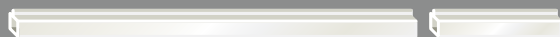

One 650mm module and one 200mm module (with any three jointers)



Two 425mm modules (with any three jointers)



One 425mm module and two 200mm modules (with any four jointers)



Four 200mm modules (with any five jointers)

Modularising ensures even finished widths and heights in the assembled unit no matter how varied the construction, e.g. several narrow filing compartments above or below a wider desktop.

Tube module examples

Recommended working lengths for flanged and plain tube profiles

875mm

650mm

425mm

200mm

Modular Furniture System Components

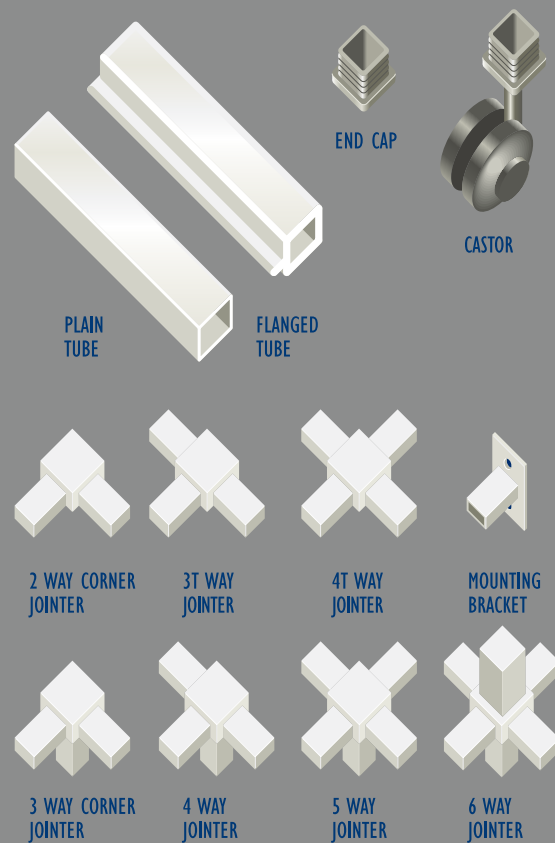

These components are available for 20mm and 25mm profiles. Standard tube finishes are plain milled, anodised silver or powder-coated in white or bronze. Tubes may also be painted with approved enamel finishes. Jointers are made from heavy-duty injection-moulded plastic in black or white.

SIMPLE ASSEMBLY TECHNIQUE



1. Read the information in **Introduction** and **Preliminary Planning** in this brochure before purchasing and cutting your tube framework. It is advisable to carefully plan your work on graph paper before purchasing your components.

2. Cut the tube precisely to your required lengths with a fine metal saw. To ensure accurate 90° cutting with handtools, use a mitrebox – with power tools, use the appropriate sawguides. Wear eye protection while using power tools. Alternatively, your stockist can pre-cut to your needs.

3. Deburr the inside edges of the cut tube with a fine flat rasp to ease jointing assembly. On the jointers, deburr any unwanted protrusions incurred in their moulding process.

4. Make a provisional assembly by laying out the components with the jointers loosely attached.

5. A plastic or rubber mallet is the only tool required for assembly. When you are satisfied that your layout is correct, firmly drive the jointers into the tube framework with the mallet. Do not use any other type of hammer.

6. Cut insert panels to exactly the same size as the inside of the tube frame. Drop the panel into the frame to be supported by the flange.

SIMPLE CONSTRUCTION EXAMPLES

Drawings are schematic and are intended to demonstrate examples of use.

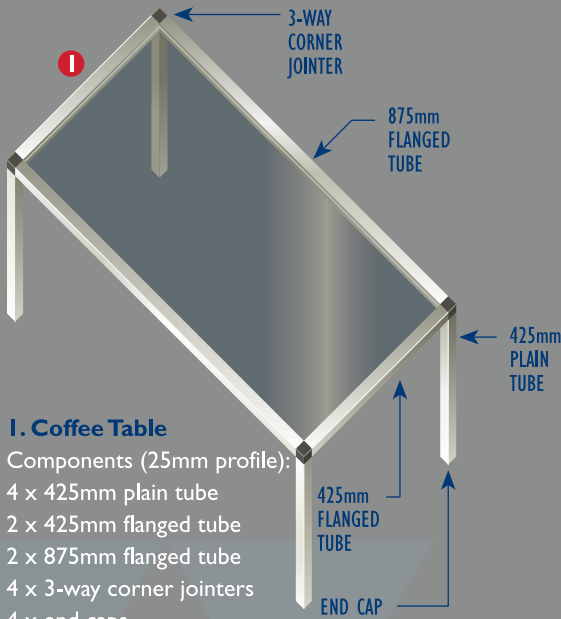

1. Coffee Table

Components (25mm profile):

- 4 x 425mm plain tube
- 2 x 425mm flanged tube
- 2 x 875mm flanged tube
- 4 x 3-way corner jointers
- 4 x end caps
- 1 x 6mm glass 875mm x 425mm

2. Coffee Table with Magazine Shelf

Components (25mm profile):

- 8 x 200mm plain tube
- 4 x 425mm flanged tube
- 4 x 875mm flanged tube
- 4 x 3-way corner jointers
- 4 x 4-way corner jointers
- 4 x end caps
- 1 x 6mm glass 875mm x 425mm
- 1 x 18mm timber 875mm x 425mm

3. Potplant stand

- 4 x 200mm plain tube
- 8 x 425mm plain tube
- 4 x 425mm flanged tube
- 4 x 3-way corner jointers
- 4 x 4-way corner jointers
- 1 x panel 425mm x 425mm (18mm timber or 6mm glass)
- 4 x end caps



4. Bookcase

- 12 x 200mm plain tube
- 8 x 200mm flanged tube
- 4 x 425mm plain tube
- 8 x 650mm flanged tube
- 4 x 3-way corner jointers
- 12 x 4-way corner jointers
- 4 x shelves 650mm x 200mm (18mm timber or 6mm glass)
- 4 x end caps

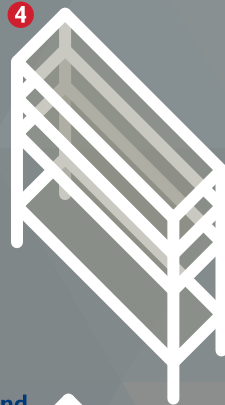

5. Foyer Table and Plant Stand

- 8 x 200mm plain tube
- 2 x 200mm flanged tube
- 3 x 425mm plain tube
- 6 x 4-way corner jointers
- 4 x 425mm flanged tube
- 2 x 650mm flanged tube
- 4 x 3-way corner jointers
- 6 x end caps
- 1 x panel 650mm x 425mm
- 1 x panel 200mm x 425mm (18mm timber or 6mm glass)

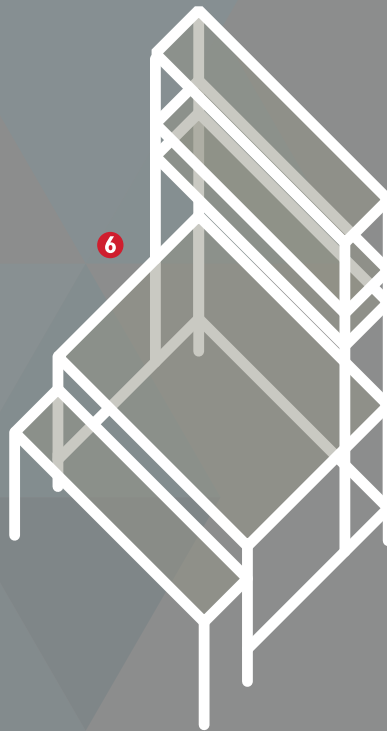
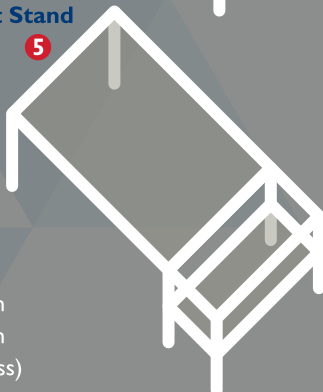

6. Computer Desk

- 12 x 200mm plain tube
- 10 x 200mm flanged tube
- 10 x 425mm plain tube
- 2 x 425mm flanged tube
- 10 x 650mm plain tube
- 1 x 875mm plain tube
- 10 x 875mm flanged tube
- 8 x 3-way corner jointers
- 4 x 3T-way corner jointers
- 14 x 4-way corner jointers
- 2 x 4T-way corner jointers
- 4 x shelves 875mm x 200mm
- 1 x desktop 875mm x 650mm

VERTICAL PANEL INSTALLATION

Modular Furniture flanged tube profiles allow tidy fixing of vertical side paneling without additional fasteners. The technique is more suitable for small units and lightweight storage, since the technique employs four flanged tubes towards the sides of the unit. This means that horizontal shelves are supported on only two flanges rather than four. Very heavy items on large shelves may cause warping, bending or breakage.

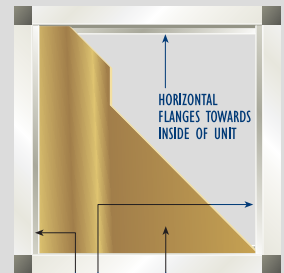

1. In this assembly, the flanges on the top and bottom (horizontal) tubes are nearest the inside of the unit. The vertical tube flanges are nearest the outside of the unit. The vertical panel is locked against movement in any direction.

2. Assemble the unit as far as the base and sides, with the jointers driven fully into the tubes. Slide the vertical panel into the space between the flanges. Pre-assemble the last flanged tube with jointers to secure the panel and complete the assembly.

PRELIMINARY PLANNING

To simplify planning and assembly, minimise the number of different tube lengths for your construction to as few as possible.

You need only four standard tube lengths as the basis for many different types of construction.

All furniture samples in this brochure have all been based on the four tube modules on opposite page (far left). In assembly, they conform to accepted ergonomic work height standards for desks and benches and generally cater for typical dimensions of home appliances, computers, office files and books.



Phone for your nearest

ULLRICH ALUMINIUM SALES CENTRE

AUSTRALIA - 1 300 650 075

NEW ZEALAND - 0800 500 338

- ALUMINIUM EXTRUSIONS
- ROLLED PRODUCTS
- FASTENINGS
- LADDERS
- SCAFFOLDS
- ULLTRACLAD CLADDING
- WINTEC WINDOWS & DOORS
- BUILDING PRODUCTS
- DECORATIVE METALS
- TEKNA MACHINERY
- ULLTIMATE SERIES WINDOWS & DOORS

Map key:
 + MANUFACTURING
 ⊕ SALES & DISTRIBUTION
 * EXTRUSION PLANT

Representative and franchised operations throughout the South Pacific

ULLRICH ALUMINIUM PTY LTD
 PO Box 246 Carole Park Queensland 4300
 20 Ron Boyle Crescent Carole Park Queensland Australia
 Tel +61 7 3718 1400 Fax +61 7 3271 1230
 ullrich@ullrich.com.au www.ullrich.com.au

ULLRICH ALUMINIUM CO LTD
 PO Box 98 843 Manukau
 Auckland 2241 New Zealand
 Tel +64 9 262 6262 Fax +64 9 262 6265
 alkalum@uacl.co.nz www.ullrich.co.nz